

**LOW POWER PWM CONTROLLER FOR OFF-LINE BATTERY CHARGER****AP3700E****General Description**

The AP3700E is a green-mode pulse width modulation (PWM) controller. It is specially designed for low power applications such as off-line battery chargers, where the needs for low standby power, space saving and low cost are all required. In a battery charger rated 5V/0.8A, the maximum standby power is only 0.18Watt.

In normal operation, the AP3700E switches on and off at a fixed switching frequency of 60 kHz. With a current limit capability of 460mA, the AP3700E can directly drive the emitter of high voltage NPN transistor. When output power falls below a given level, the IC enters skip cycle mode to reduce power consumption.

The AP3700E also features under-voltage lockout, over-current and short circuit protections.

The AP3700E is available in TO-92 package.

Features

- Current Mode Control with Skip Cycle Capability
- Lower Operating Current: 0.45mA
- Fixed Switching Frequency: 60 kHz
- Frequency Dithering for Low EMI: ± 2.5 kHz
- Under-Voltage Lockout Protection
- Over-Current Protection
- Internal Short Circuit Protection
- Higher Output Voltage at OUT Terminal
- Low Total Cost Solution

Applications

- Battery Chargers
- Off-Line Power Supplies

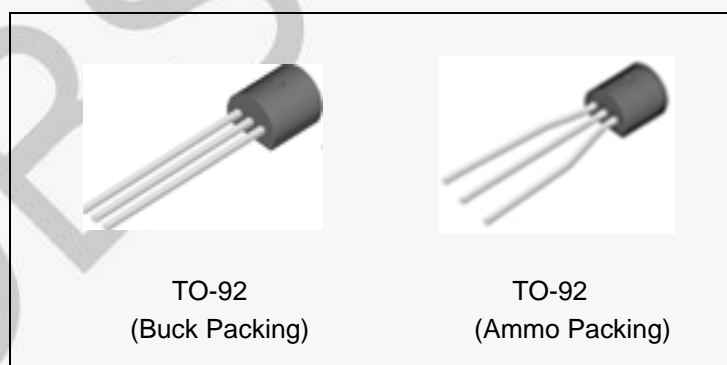

Figure 1. Package Types of AP3700E



PART OBSOLETE

Data Sheet

LOW POWER PWM CONTROLLER FOR OFF-LINE BATTERY CHARGER AP3700E

Pin Configuration

Z Package
(TO-92)

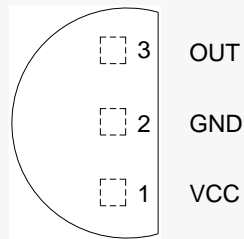

Figure 2. Pin Configuration of AP3700E (Top View)

Pin Description

Pin Number	Pin Name	Function
1	VCC	The power supply of the IC, and is generally connected to opto-coupler's emitter
2	GND	Supply ground
3	OUT	The output pin, connected to the emitter of NPN transistor or the source of MOSFET



PART OBSOLETE

Data Sheet

LOW POWER PWM CONTROLLER FOR OFF-LINE BATTERY CHARGER AP3700E

Ordering Information

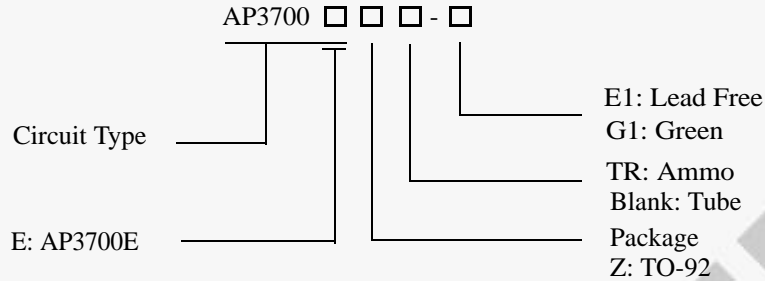

Package	Switching Frequency	Temperature Range	Part Number		Marking ID		Packing Type
			Lead Free	Green	Lead Free	Green	
TO-92	60kHz	-40 to 85°C	AP3700EZ-E1	AP3700EZ-G1	3700EZ-E1	3700EZ-G1	Bulk
			AP3700EZTR-E1	AP3700EZTR-G1	3700EZ-E1	3700EZ-G1	Ammo

BCD Semiconductor's Pb-free products, as designated with "E1" suffix in the part number, are RoHS compliant. Products with "G1" suffix are available in green packages.

Absolute Maximum Ratings (Note 1)

Parameter	Value	Unit
Supply Voltage	-0.3 to 6.0	V
Voltage at OUT (Note 2)	-0.3 to 40	V
Output Current at OUT	Internally limited	A
Power Dissipation	0.6	W
Operating Junction Temperature	150	°C
Storage Temperature	-65 to 150	°C
Lead Temperature (Soldering, 10s)	300	°C
ESD (Machine Model)	200	V

Note 1: Stresses greater than those listed under "Absolute Maximum Ratings" may cause permanent damage to the device. These are stress ratings only, and functional operation of the device at these or any other conditions beyond those indicated under "Recommended Operating Conditions" is not implied. Exposure to "Absolute Maximum Ratings" for extended periods may affect device reliability.

Note 2: The Breakdown Voltage. The actual operating voltage can not be greater than the value listed here.



PART OBSOLETE

Data Sheet

LOW POWER PWM CONTROLLER FOR OFF-LINE BATTERY CHARGER AP3700E**Electrical Characteristics**(V_{CC}=4.5V, T_J=25°C, unless otherwise specified.)

Parameter	Symbol	Conditions	Min	Typ	Max	Unit
UVLO SECTION						
Start-up Voltage	V _{TH(ST)}		5.5	5.75	5.95	V
Minimal Operating Voltage	V _{OPR(min)}		3.6	3.8	4.0	V
STANDBY CURRENT SECTION						
Start-up Current (Note 3)	I _{ST}	V _{CC} =4.5V		0.22	0.45	mA
Operating Current	I _{CC(OPR)}			0.45	0.7	
V _{CC} Zener Voltage	V _Z	I _{CC} =10mA	6	6.3		V
Dynamic Impedance	R _{VCC}	V _{CC} =3.8 to 4.8V		18		kΩ
INTERNAL OSCILLATOR						
Switching Frequency	f _{SW}		50	60	75	kHz
Frequency dithering			±2	±2.5	±3	kHz
Temperature Stability		-40 to 85°C		5	10	%
DRIVE OUTPUT SECTION						
OUT Turn-on Voltage	V _{OUT(ON)}			9.5	12	V
OUT Turn-off Voltage	V _{OUT(OFF)}		5	5.5	6.5	V
Rise Time	T _R	C _L =1nF, 15Ω pull-up		60		ns
Fall Time	T _F	C _L =1nF, 15Ω pull-up		30		
Maximum Duty Cycle	D _{MAX}	V _{OPR(min)} + 0.2V	67	75	84	%
Minimum Duty Cycle				3		
Driver OUT On-Resistance	R _{OUT}	I _{OUT} =0.06A		3		Ω
Switch Off Current (OUT)		Driver off, V _{OUT} =10V		20	40	μA
Effective Current Limit	I _{LIM}	V _{CC} = V _{OPR} +0.1V	460			mA
OUT Current Coefficient	G _A			-0.3		A/V

Note 3: AP3700E is an emitter drive controller, the PWM controller will start up only when the voltage on the OUT pin rises up to its threshold value.



PART OBSOLETE

Data Sheet

LOW POWER PWM CONTROLLER FOR OFF-LINE BATTERY CHARGER AP3700E

Typical Performance Characteristics

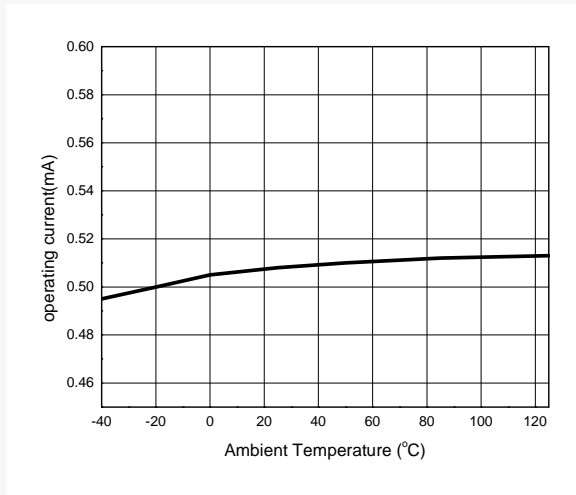

Figure 4. Operating Current vs. Ambient Temperature

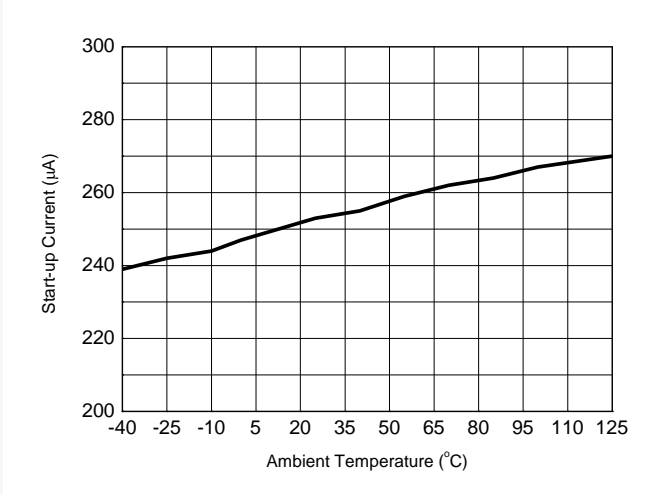

Figure 5. Start-up Current vs. Ambient Temperature

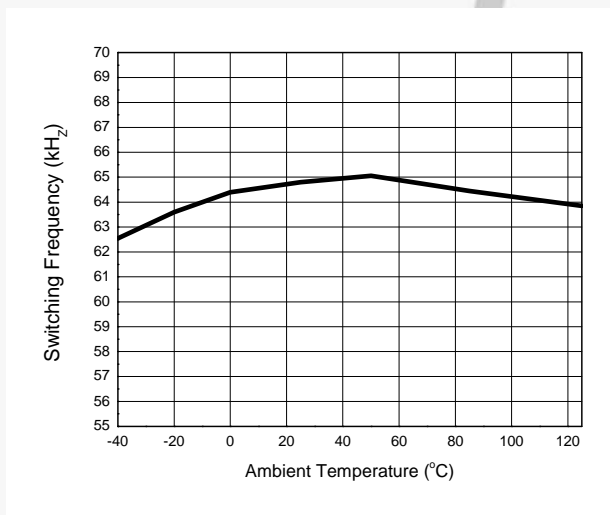

Figure 6. Switching Frequency vs. Ambient Temperature

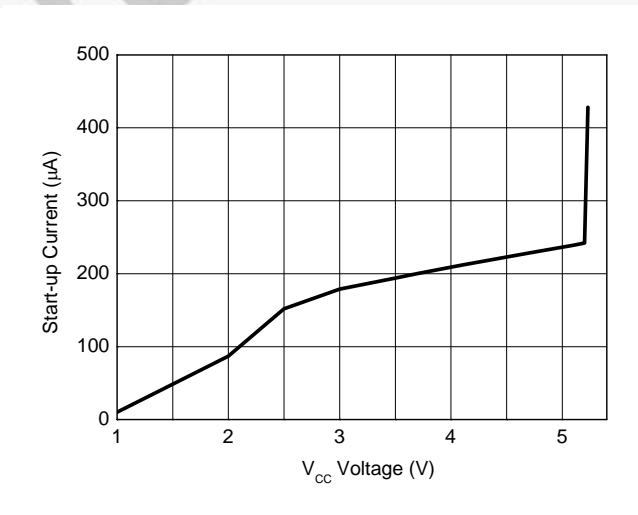

Figure 7. Start-up Current vs. V_{CC} Voltage



PART OBSOLETE

LOW POWER PWM CONTROLLER FOR OFF-LINE BATTERY CHARGER AP3700E

Typical Performance Characteristics (Continued)

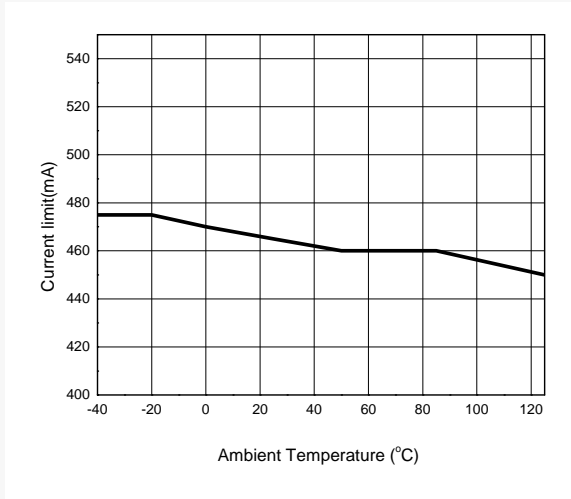

Figure 8. Current Limit vs. Ambient Temperature

OBSOLETE - PART DISCONTINUED

OBSOLETE

LOW POWER PWM CONTROLLER FOR OFF-LINE BATTERY CHARGER AP3700E

Function Description

1. Startup Circuit

Figure 3 is the functional block diagram of AP3700E, and there are 3 external pins: the VCC pin, the OUT pin and GND pin. In typical application shown by Figure 10, the VCC pin is used for both bias supply and feedback control. The OUT pin directly drives external NPN transistor or MOSFET, and also provides initial bias power for UVLO comparator. When the IC works in PWM mode, the auxiliary winding will supply the V_{CC} enough operating current.

Figure 9 shows the start-up sequence of the V_{CC} and the V_{OUT}.

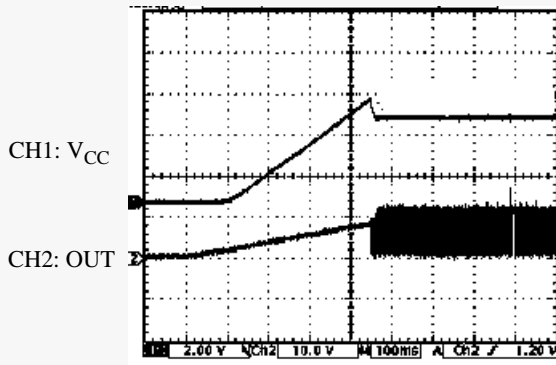

Figure 9. Start-up Sequence of V_{CC} and V_{OUT}

2. V_{CC}/Feedback Control

An opto-coupler and secondary constant voltage/current controller consists of voltage feedback network. When load is heavy, the voltage on VCC will be lower to enlarge duty cycle; on the contrary, if load drops, the voltage on VCC will rise to reduce duty cycle.

3. Frequency Dithering

Frequency dithering is performed by periodically spreading a single switching frequency into adjacent frequency band, so the peak energy is spread. This technique can improve EMI by reducing both quasi-peak and average EMI emissions.

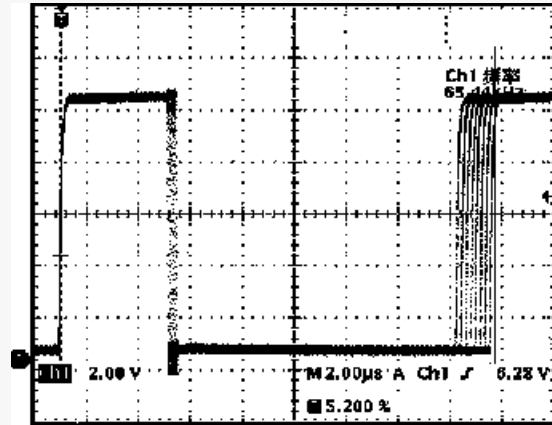

Figure 10. Frequency Dithering Influences the Switching Cycle

AP3700E has reference switching frequency of 60 kHz, and its frequency deviation is ± 2.5 kHz in period of 2ms. Figure 10 shows the frequency dithering influence to the waveform .

4. Current Limit Control

The AP3700E employs current mode control to improve transient response and voltage stability. In Figure 11, the external inductor current through the OUT pin is converted to a voltage by an internal resistor, and this voltage will participate to control duty cycle and peak inductor current.



PART OBSOLETE

Data Sheet

LOW POWER PWM CONTROLLER FOR OFF-LINE BATTERY CHARGER

AP3700E

Mechanical Dimensions

TO-92 (Bulk Packing)

Unit: mm(inch)

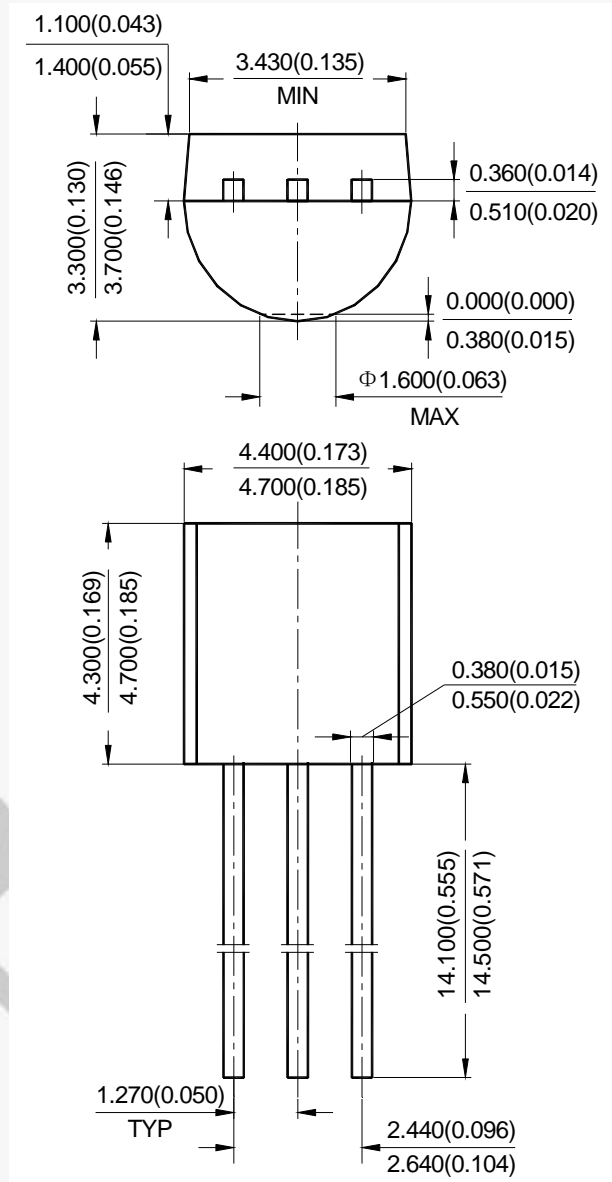

PART OBSOLETE



BCD Semiconductor Manufacturing Limited

<http://www.bcdsemi.com>

IMPORTANT NOTICE

BCD Semiconductor Manufacturing Limited reserves the right to make changes without further notice to any products or specifications herein. BCD Semiconductor Manufacturing Limited does not assume any responsibility for use of any its products for any particular purpose, nor does BCD Semiconductor Manufacturing Limited assume any liability arising out of the application or use of any its products or circuits. BCD Semiconductor Manufacturing Limited does not convey any license under its patent rights or other rights nor the rights of others.

MAIN SITE

- Headquarters

BCD Semiconductor Manufacturing Limited

No. 1600, Zi Xing Road, Shanghai Zizhu Science-based Industrial Park, 200241, China
Tel: +86-21-24162266, Fax: +86-21-24162277

- Wafer Fab

Shanghai SIM-BCD Semiconductor Manufacturing Co., Ltd.

800 Yi Shan Road, Shanghai 200233, China
Tel: +86-21-6485 1491, Fax: +86-21-5450 0008

REGIONAL SALES OFFICE

Shenzhen Office

Shanghai SIM-BCD Semiconductor Manufacturing Co., Ltd., Shenzhen Office
Room E, 5F, Noble Center, No.1006, 3rd Fuzhong Road, Futian District, Shenzhen,
518026, China
Tel: +86-755-8826 7951
Fax: +86-755-8826 7865

Taiwan Office

BCD Semiconductor (Taiwan) Company Limited
4F, 298-1, Rui Guang Road, Nei-Hu District, Taipei,
Taiwan
Tel: +886-2-2656 2808
Fax: +886-2-2656 2806

USA Office

BCD Semiconductor Corp.
30920 Huntwood Ave. Hayward,
CA 94544, USA
Tel : +1-510-324-2988
Fax: +1-510-324-2788